



**ENGUIE**

User Manual



P275 ST

PLEASE READ THIS MANUAL CAREFULLY BEFORE USING YOUR E-BIKE

# Preface

Thank you for choosing the ENGWE series of products. In order to familiarize yourself with the use and ensure a safer ride, please read this manual carefully.

1. Before riding, carefully check if all components are in good condition to ensure your safety. If any problems are found, please contact the seller in a timely manner.

2. Please comply with the traffic regulations in your local area. Slow down in rainy, snowy, and slippery road sections, and increase braking distance when braking to ensure safety.

3. The vehicle can be ridden in rainy and snowy weather, but when the waterline approaches the center of the motor, in order to ensure your safety and prevent damage to the internal circuit of the vehicle, please avoid riding through water.

4. The vehicle battery is a safe battery, but it is prohibited to touch the metal pieces of the battery discharge component with your hands, and you should never touch the battery electrodes and the vehicle circuit with other metal objects to avoid the risk of short circuit.

5. It is prohibited to use the vehicle's matching battery to power other electrical appliances, as this may cause damage to the battery. Please use the original charger to charge the battery.

6. Do not disassemble or dismantle components by yourself. If replacement is needed, please purchase standard components from the seller.

7. Please avoid washing the vehicle directly with water. If cleaning is necessary, use a cleaning tool to wipe it.

8. Regularly maintain your brakes, tires, and other movable components to ensure the normal operation of your vehicle.

## TABLE OF CONTENTS

### Preface

<b>1. Vehicle Basic Information</b>	01
1.1 Vehicle Introduction	01
1.2 Vehicle Parameters	02
1.3 Product Applicable Characteristics	02
<b>2. Vehicle Assembly Instructions</b>	03
2.1 Vehicle Component Details	03
2.2 Bolt Size/Tools/Torque Specifications	05
2.3 Vehicle Assembly and Adjustment	05
2.4 Tire Pressure	10
<b>3. Pre-ride Instructions</b>	11
3.1 Riding Techniques	11
3.2 Pre-ride Preparation	11
<b>4 Display Panel Instructions</b>	12
4.1 Display Function	12
4.2 Display Interface	12
4.3 Key Definition	12
4.4 Display Fault Code Description	14
<b>5. Battery and Charger</b>	15
5.1 Battery Technical Data and Precautions	15
5.2 Battery Usage Instructions	15
5.3 How to Charge the Battery	16
5.4 Battery Storage and Disposal	17
5.5 Charger Technical Data and Precautions	17
<b>6. Common Faults and Maintenance</b>	18
<b>7. Warranty Service</b>	19
<b>8. Disclaimer</b>	22

# 1. Vehicle Basic Information

## 1.1 Ebike Introduction

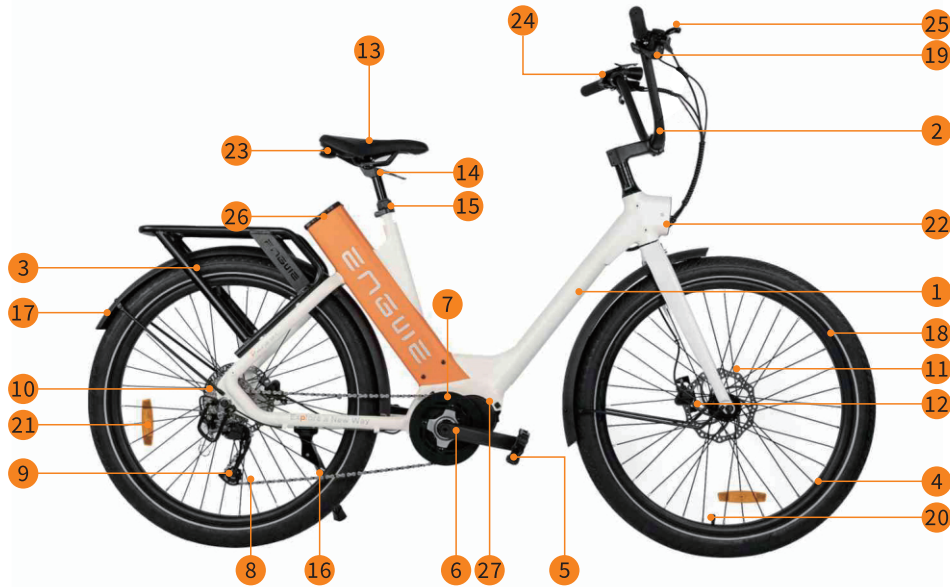

1	Frame
2	Handlebar
3	Rear rack
4	Front wheel
5	Pedal
6	Crank
7	Chainring
8	Belt
9	Rear derailleur
10	Freewheel
11	Brake disc
12	Brake caliper
13	Saddle
14	Seatpost

15	Seatpost clamp
16	Kickstand
17	Fender
18	Tire
19	Manual gear shifter
20	Valve mouth
21	Reflective strip
22	Headlight
23	Rear light
24	Instrument panel
25	Brake lever
26	Battery
27	Motor

## 1.2 Vehicle Parameters

Project	Parameters
Model	P275 ST
Vehicle Dimensions (in)	74*28*47 (188.5*71*121CM)
Wheel Diameter (in)	27.5
Frame Material	Aluminum alloy
Maximum Load Weight (lb)	220(100KG)
Vehicle Weight (lb)	56.4(25.6KG)
Maximum Speed (Km/h)	25(15.5mph)
Rear Derailleur Level	9
Vehicle Operating Temperature	-4-140°F(-20-60°C)
Battery Rated Voltage (V)	36
Battery Capacity (AH)	19.2
Motor Power (W)	250
Charger Input Voltage (AC-V)	100-240
Charger Output Voltage (DC-V)	42
Charger Maximum Output Current (A)	3A

## 1.3 Product Applicable Characteristics

This product is a vehicle designed specifically for urban commuting, with strong power and long range. Suitable for riding on urban paved roads, flat gravel roads, and improved small roads with moderate slopes and non-slip tires. A rear shelf has been designed at the tail, which can accommodate objects up to 25 KG. Adopting a pull-out battery box design, the battery can be easily removed by simply turning the key. High brightness headlights make riding safer at night.

## 2. Vehicle Assembly Instructions

### 2.1 Vehicle Component Details

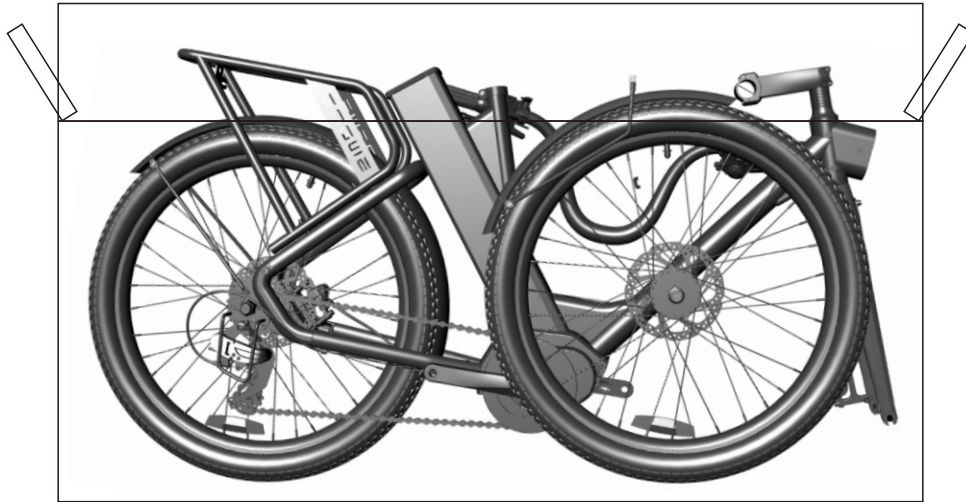

Vehicle Packaging Details		
Packaging Box	Complete Vehicle	One Unit
	Accessory Box	One Instruction Manual
		Tool Kit
		Pedals
		Charger
		Other Accessories

### Tool Kit Details

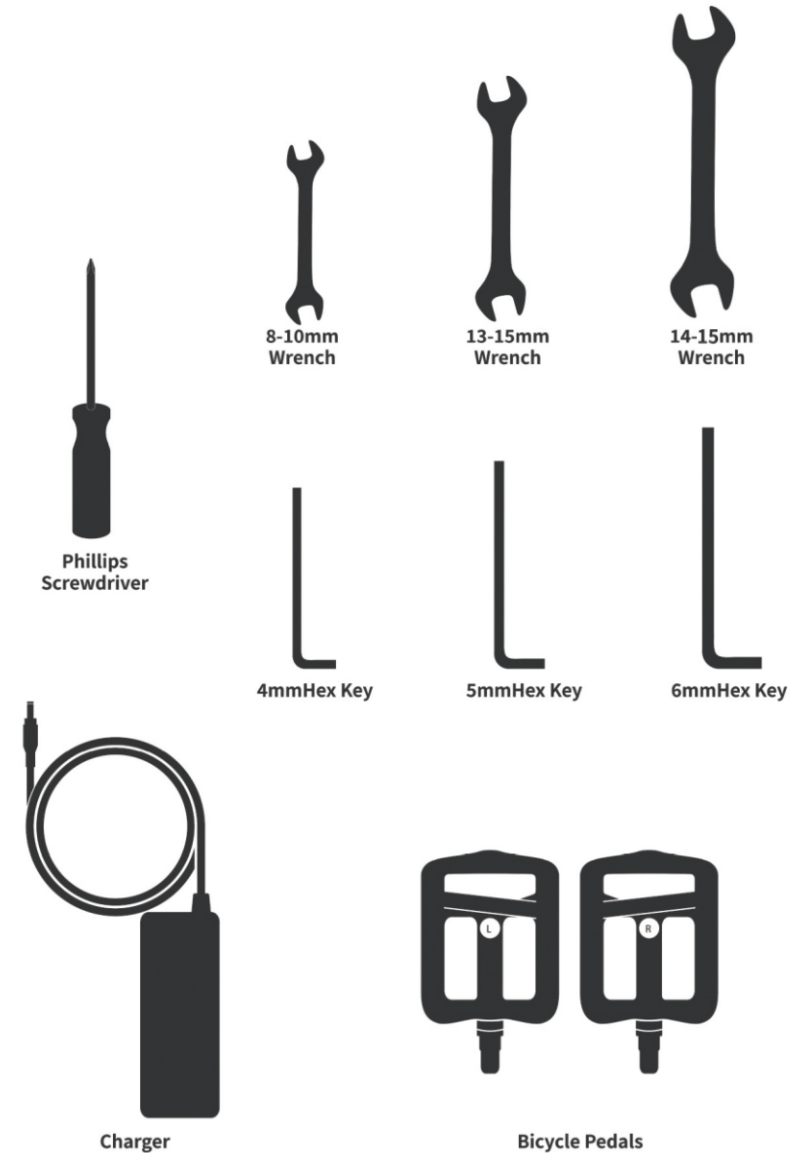

## 2.2 Bolt Size/Tools/Torque Specifications

Assembly Parts	Tools for Use	Torque Value N.m
Front Axle	8-10mm wrench	20
Handlebar	13-15mm wrench	15
Pedal	14-15mm wrench	20
Crank	4mm Hex Key	15
Rear rack	5mm Hex Key	10
Saddle	6mm Hex Key	6

## 2.3 Vehicle Assembly and Adjustment

2.3.1 Remove the front wheel.

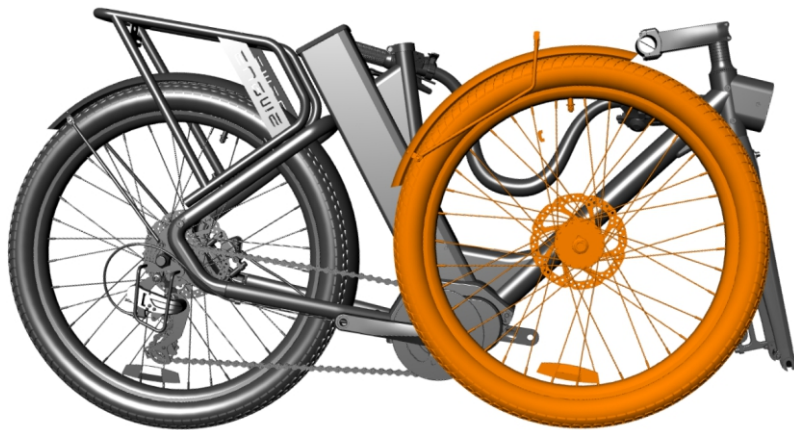

2.3.2 Take off the protective covers on both sides of the front wheel.



2.3.3 Remove the foam wrapped around the handlebar and then adjust the instrument to its proper position. Align the handlebar and ensure the "cross mark" is at the center. Using a 4mm hex wrench, turn clockwise to install the 4 screws. The installation sequence is shown in the figure below. Once the screws and the handlebar are in the correct position, tighten the screws, applying appropriate force.

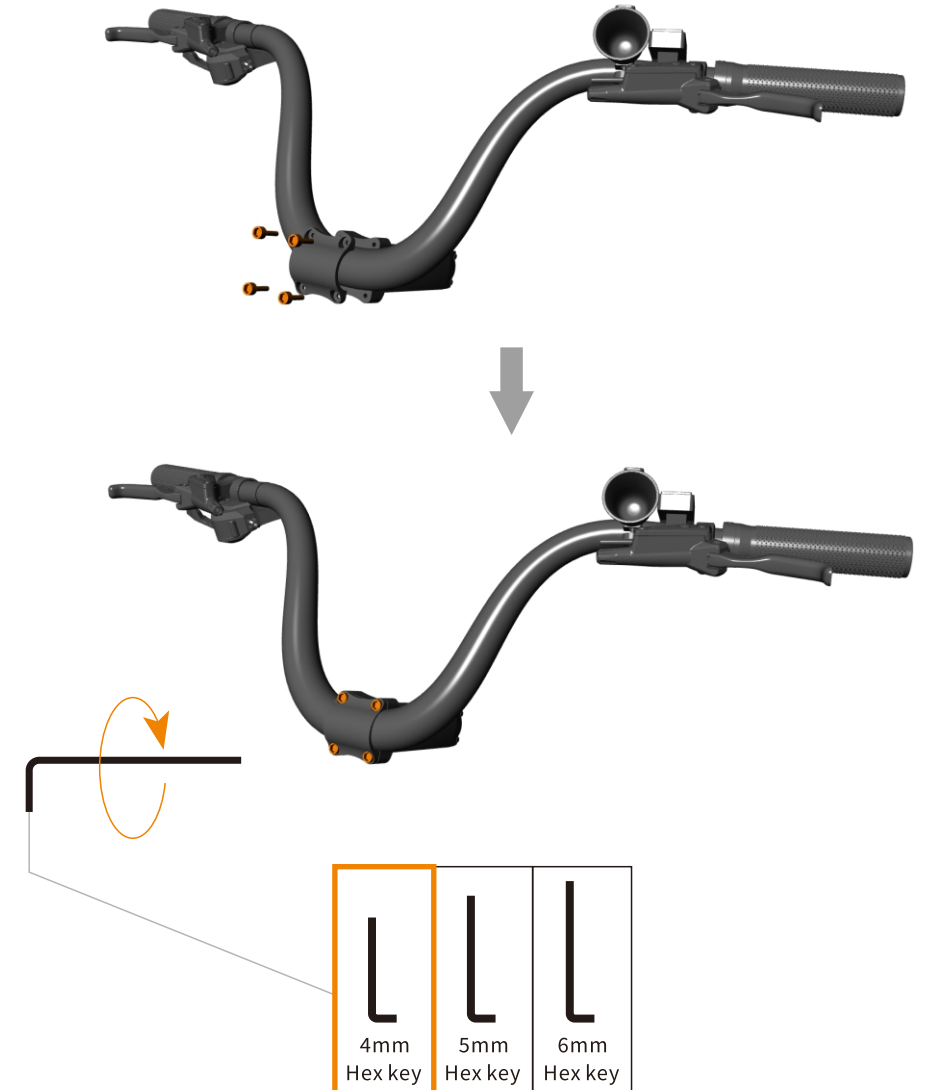

2.3.4 Remove the foam wrapped around the front fender, as shown in the figure below. Align the front fender lug with the front fork installation hole and tighten the screw using a 4mm hex wrench. Align the front fender bracket with the installation hole, as shown in the figure below, and tighten the screw with a 4mm hex wrench.

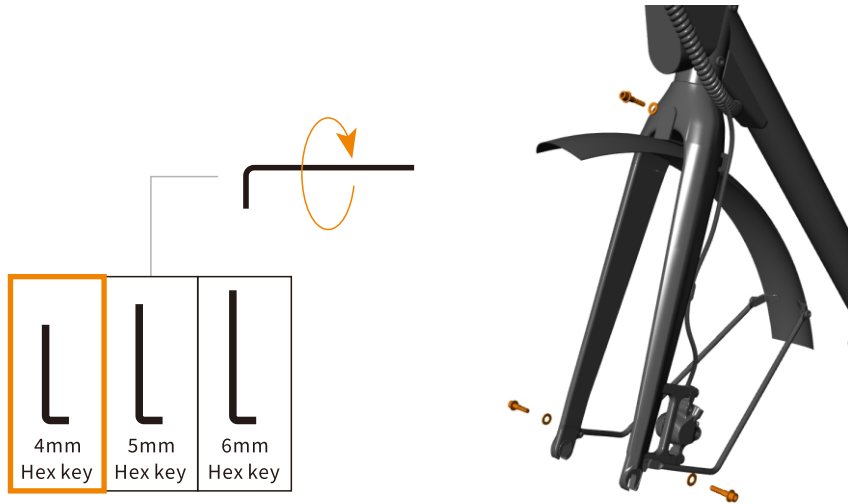

2.3.5 Place the nut and washer on the front wheel as shown in the figure below, following the sequence.



2.3.6 Clamp the front wheel with the front fork and lock the front wheel screw with a 15mm open-end wrench.



2.3.7 Remove the foam wrapped around the rear fender, as shown in the figure below. Align the rear fender bracket with the installation hole and tighten the screw using an 4 hex wrench.

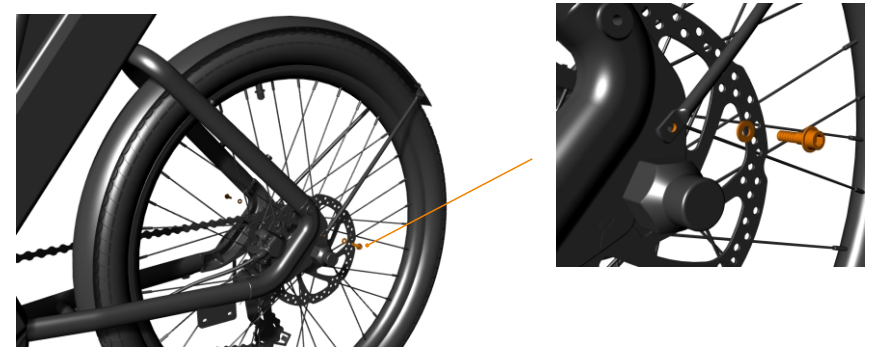

2.3.8 Take the cargo rack out of the cardboard box, remove the wrapped foam, align it with the installation hole as shown in the figure below, and tighten the screw with an 4 hex wrench.

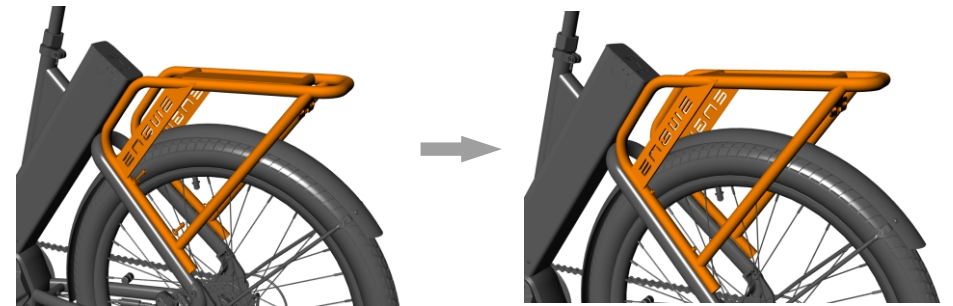

2.3.9 When installing the pedals, note the markings "R" (right) and "L" (left). The pedal marked with "R" should be installed on the right side of the bike and tightened clockwise with a 15mm open-end wrench; The pedal marked with "L" should be installed on the left side of the bike and tightened counterclockwise with a 15mm open-end wrench.

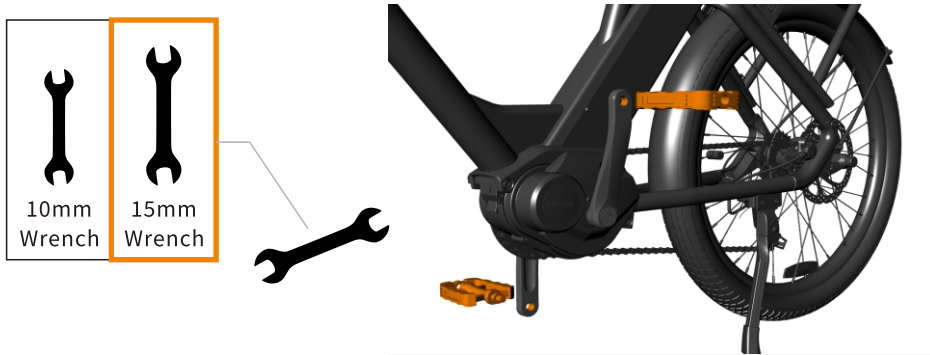

### 2.3.10 Saddle Adjustment:

\*The seat tube is inserted into the middle tube of the frame, and the screw on the tube clamp is locked with a 4mm wrench.

\*After the screw is locked, press the adjustment lever under the seat cushion by hand to adjust the seat chair height.

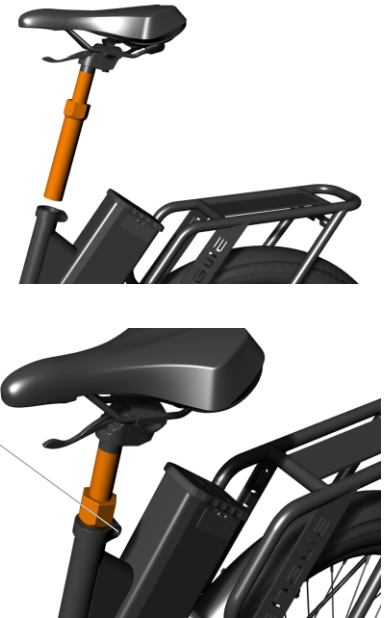
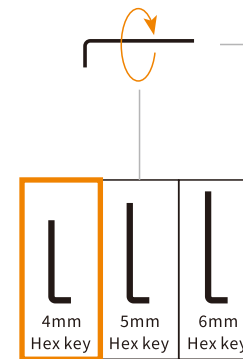

### 2.4 Tire Pressure

Please ensure that the tires have sufficient pressure. Insufficient pressure can cause damage to the rims and reduce riding mileage. Please check your tires every 30 days. If the pressure is insufficient, use an inflation device to replenish the standard MPa pressure for your tires. The inflation method is shown in the figure:



## 3. Pre-ride Instructions

### 3.1 Riding Techniques

\*When the vehicle instrument is in gear 0, the motor is in a no-output state, and the vehicle can be ridden like a normal bicycle.

\*When the instrument is in gears 1-5, it represents different speed levels, with gear 1 being the slowest and gear 5 being the fastest.

\*Lower gears will make your battery last longer and make your ride safer.

\*More power is needed to restore the original speed after emergency braking.

\*Use the mechanical transmission to maintain the optimal pedaling frequency with the motor speed, making the riding experience more effortless.

\*When shifting gears with the mechanical transmission, lightly step on the pedal to reduce wear on the transmission system.

\*When riding in the rain, please maintain a low speed, which will provide greater friction for the tires.

\*More weight will accelerate battery consumption.

\*Do not start the bicycle by placing one foot on the pedal and crossing the other leg over the seat cushion, as this may cause the vehicle to suddenly accelerate. The correct way to start is to sit on the seat, hold the handlebars with both hands, and then start the vehicle.

### 3.2 Pre-ride Preparation

Regardless of your level of experience, you should carefully read the "User Manual" and perform a safety check on the vehicle. In addition, please make sure you are familiar with the following vehicle-related information.

Before riding, please check the following information about the vehicle:

\*Whether key parts such as the front wheel, rear wheel, saddle, and handlebars are loose. If they are loose, they must be tightened before riding.

\*Whether the brakes and handles are functioning properly.

\*Whether the tire pressure is normal.

\*Whether the battery is fully charged.

\*When riding at night, check if the front and rear lights of the vehicle are working properly.

\*Whether the display components of the instrument are displaying correctly.

\*Please wear a cycling helmet and protective gear in accordance with local laws and regulations.

## 4. Instrument Panel Instructions

### 4.1 Display Function

Power Display	Speed Display	Headlight Display	Gear Display
Light Control Headlight	Subtotal Mileage	Tiding Time	Average Speed
Maximum Speed	Total Mileage Display	Fault Code Display	

### 4.2 Display Interface

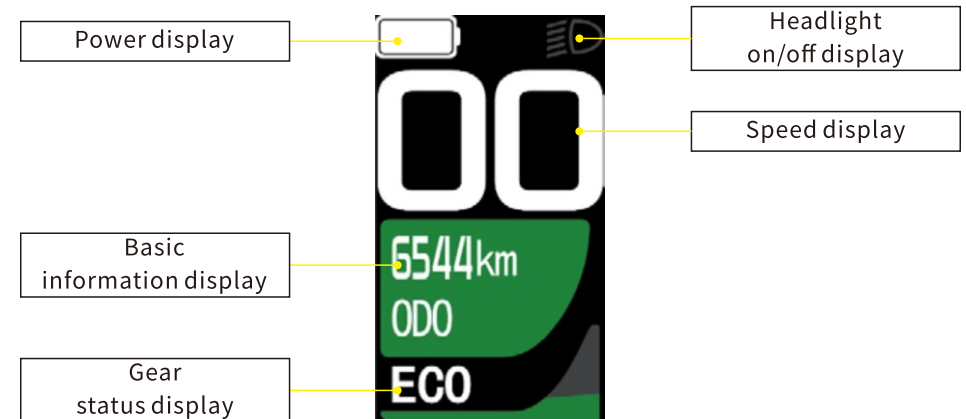

### 4.3 Key Definition

Sleep/wake button: “”;

Display function switch key: “i”;

Adjustment key: “^”, “v”;

#### 4.3.1 Power on/off

Press and hold “” for 2 seconds in the dormant state of the instrument, the instrument will light up and the vehicle will start;

Press and hold the “” button for 2 seconds while the vehicle is turned on, and the instrument panel will turn off and the vehicle will shut down.



#### 4.3.2 Gear adjustment display

Short press the  $\wedge$  key or  $\vee$  key to switch the power assist gear, there are five modes in total: OFF is 0th gear/ECO is 1st gear/TOUR is 2nd gear/SPORT is 3rd gear/SHIFT is 4th gear/BOOST is 5th gear, larger gears can provide more power. When the instrument is turned on, the default gear is OFF, and when OFF is displayed, the vehicle has no power assist at this time. The assist gear selection interface is as shown in the figure below:



#### 4.3.3 Basic information switching

In the basic interface, short press the "i" button to switch the subtotal mileage, riding time, average speed, maximum speed, and total mileage display information,

Cyclic display: subtotal mileage (TRIP)→riding time (TRIP TIME)→total mileage (ODO)→riding average speed (AVG)→riding maximum speed (MAX)→riding motor power (M PWR)→riding Pedal power (H PWR) → cycling power consumption (CONS) → remaining mileage (RANGE). The mode switching interface is as shown in the figure

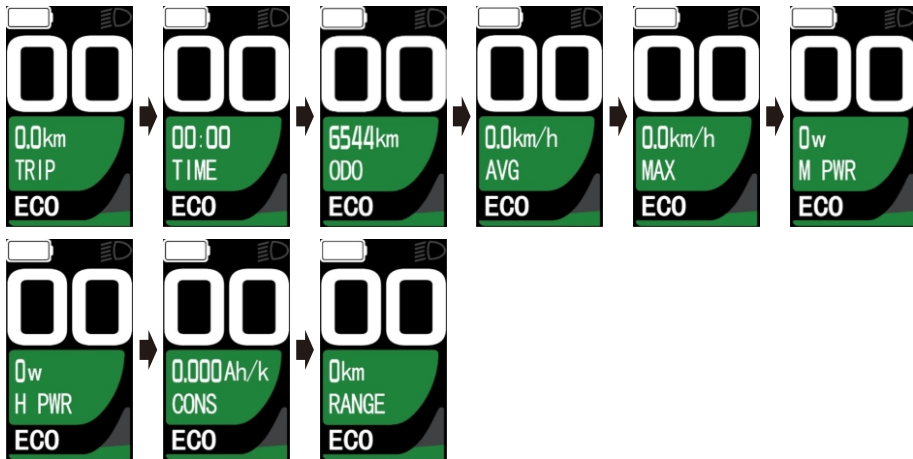

#### 4.3.4 Headlights on/off

Press and hold the  $\wedge$  key for 2 seconds, the headlights will be turned on, and the instrument headlight indicator icon will light up;

Press and hold the  $\wedge$  key again for 2 seconds, the headlights are turned off, and the headlight indicator icon goes out.

As shown below:



Headlights on



Headlights off

#### 4.3.5 Power-assisted push mode

Press and hold the  $\vee$  button on the meter to enter the power-assisted push mode, and the gear position will be displayed. Release the  $\vee$  key to exit the power-assisted push mode. The switching interface of boost promotion mode is as shown in the figure below:



#### 4.3.6 Power display

When the battery level is 5 bars, the battery is fully charged or nearly full; is 0%, the battery needs to be charged immediately; as shown below:



### 4.4 Display Fault Code Description

Pay attention to safety during use, and do not plug or unplug the meter when it is powered on.

Avoid bumping the instrument as much as possible.

Regarding the background parameter setting of the meter, please do not change it arbitrarily, otherwise normal riding cannot be guaranteed.

When the instrument cannot be used normally, it should be repaired as soon as possible, and do not disassemble the instrument without permission.

Error code	Problem
01	Controller phase line overcurrent fault
02	Controller power line overcurrent fault
03	Controller HALL failure
05	Controller Temperature Fault
30	Meter communication failure
31-51	Controller failure
06	Motor Temperature Fault

## 5. Battery and Charger

### 5.1 Battery Technical Data and Precautions

For transportation safety, the battery is guaranteed to have 30-40% charge when it leaves the factory. This charge will decrease with the length of transportation time. If you receive the goods, please charge the battery in time.

Battery capacity (AH)	19.2
Battery level (WH)	691
Rated voltage (V)	36
Maximum charging voltage (V)	22
Maximum charging current (A)	3
Battery type	Li-ion
Ambient operating temperature	-5~45 °C
Cycle life	≥1000 times
Charging temperature	0~45 °C
Waterproof rating	IPX6

Your bicycle is powered by a lithium-ion (Li-Ion) battery. Please always follow the following instructions when operating, charging, and using it:

\*The vehicle battery is only for use with this vehicle. It is strictly prohibited to connect the battery to other electronic devices, as this may risk damaging the battery.

\*Do not modify, open, or disassemble the battery pack. Modifying or disassembling the battery may cause short circuits, fires, or malfunctions.

\*The battery is heavy, please handle it with care to avoid dropping it.

\*Do not let any sharp or metal objects come into contact with the battery electrodes and charging ports, as there is a risk of short circuits and fires.

\*Do not let the battery overheat and avoid excessive exposure.

\*Do not expose the battery to open flames or high temperatures from radiators.

\*Do not immerse the battery in water.

\*Before performing tasks such as installation, maintenance, cleaning, or repairs, turn off the power and unplug the charger or battery plug. When the bicycle is turned on, touching the contact points may cause electric shock or injury.

### 5.2 Battery Usage Instructions

Before assembling the battery, please make sure that there are no foreign objects in the electrode area of the vehicle. If there are any, they must be cleaned off, otherwise it will cause the risk of battery short circuit and damage. Steps matched with corresponding pictures.

#### 5.2.1

\*Raise the seat height to the highest;

\*Align the battery with the installation position and insert it directly to the bottom, insert the key into the keyhole, turn the key clockwise, the battery can be locked.



#### 5.2.2 How to remove the battery

\*Raise the seat height to the highest;

\*Lift the rubber plug, insert the key into the keyhole, press and turn the key in counterclockwise direction, then pull out the key and hold the battery and then pull out the key, then hold the battery cover with your hands and lift the battery up to remove the battery.



### 5.3 How to Charge The Battery

The charging time for the battery is 6-8 hours. During charging, both the charger and the battery should be in a good environment. Charging in direct sunlight, rain, or damp conditions is strictly prohibited as it may cause damage to the charger, battery, and the risk of electric shock. It is also prohibited to keep the charger connected to the battery for a long time, as this may reduce the lifespan of both the battery and the charger.

5.3.1 First, connect the DC end of the charger cable to the battery charging port.



5.3.2 When inserting the AC end of the charger into the AC power socket, at this time the charger indicator light is red, charging begins at this time;

5.3.3 When the charger indicator light turns green, the battery is fully charged. Unplug the charger from both the AC and DC ends in sequence to complete the charging.



## 5.4 Battery Storage and Disposal

5.4.1 Storage: If the bicycle is not used for a long time, please remove the battery and store it in a dry, well-ventilated place, and ensure that the storage temperature is between 25-35°C (77-95°F). Also, make sure to charge the battery at least once every three months to keep the battery level at least 3 bars (40-50%), which can effectively extend the battery life.

5.4.2 Disposal: When the battery is no longer usable, do not dispose of it in your household waste! All batteries and chargers must be disposed of in an environmentally friendly manner according to the battery disposal regulations of your country or region.

## 5.5 Charger Technical Data and Precautions

AC input voltage (V)	100-240
Charging voltage (V)	42
Charging current (A)	2
Frequency (Hz)	50/60
Battery type	Li-ion
Ambient operating temperature	0~40 °C

The following regulations should be followed when using the charger:

- \* The charger should be placed on a level and non-heated surface.
- \* Charge the battery in a dry, well-ventilated place, and ensure that the charger is not covered during the charging process.
- \* When charging the battery, connect the charger to the battery charging port first, and then connect it to the socket.
- \* Avoid bumping or impacting the charger, as it may damage the charger.
- \* Avoid leaving the charger plugged into the battery for a long time. If the battery is fully charged, unplug the charger in a timely manner, as it may affect the battery's lifespan.

## 6. Common Faults and Maintenance

Sequence	Fault phenomenon	Fault cause analysis	Solution
1	Vehicle not powered	<ol style="list-style-type: none"> <li>1. Power lock not properly opened, battery not supplying power properly.</li> <li>2. Battery not installed properly.</li> <li>3. Power switch circuit loose or disconnected.</li> <li>4. Battery not powered.</li> </ol>	<ol style="list-style-type: none"> <li>1. Turn the ignition lock to the ON position, then power on.</li> <li>2. Install the battery properly.</li> <li>3. Open the frame electronic control component installation box, connect the wires properly.</li> <li>4. Contact your retailer for assistance.</li> </ol>
2	Vehicle does not move after powering on	<ol style="list-style-type: none"> <li>1. Check if the gear lever is in gears 1-5, if it is in gear 0, the motor will not output power.</li> <li>2. Loose or disconnected speed control lever circuit.</li> </ol>	<ol style="list-style-type: none"> <li>1. Adjust the instrument to gears 1-5 and use the speed control lever or start with pedal assist.</li> <li>2. Connect the speed control lever circuit properly.</li> <li>3. Contact your retailer for assistance.</li> </ol>
3	The vehicle rides normally and the instrument panel does not show the speed	<ol style="list-style-type: none"> <li>1. The white speed wire at the controller end is loose or disconnected.</li> <li>2. Instrument panel malfunction.</li> </ol>	<ol style="list-style-type: none"> <li>1. Open the frame electronic control component installation box and connect the white speed wire.</li> <li>2. Contact your retailer for assistance.</li> </ol>
4	The front/rear lights are not working	<ol style="list-style-type: none"> <li>1. The front/rear light wires are loose or disconnected.</li> <li>2. Front/rear light malfunction.</li> </ol>	<ol style="list-style-type: none"> <li>1. Open the frame electronic control component installation box and connect the front/rear light wires.</li> <li>2. Contact your retailer for assistance.</li> </ol>
5	Gear shifting is not smooth	<ol style="list-style-type: none"> <li>1. The rear derailleur protector is deformed.</li> <li>2. The gear shifting wire is loose.</li> </ol>	<ol style="list-style-type: none"> <li>1. Use a wrench to restore the rear derailleur protector to its normal position.</li> <li>2. Adjust the gear shifter fine-tuning screw.</li> </ol>

## 7. Warranty Service

### 7.1 Warranty Terms

7.1.1 The warranty only applies to the original owner of the electric bike purchased through Engwe online or physical stores.

7.1.2 The warranty period starts when the customer receives the electric bike and terminates immediately upon the expiration, sale, or transfer to another person. Any subsequent owner or transferee is not eligible for the limited warranty.

7.1.3 For non-human-induced damages during the warranty period, we will provide free replacement parts. After the warranty period, the customer is responsible for the cost of replacement parts and shipping.

### 7.2 Warranty Coverage

Warranty content for accessories			
	Accessory name	Shelf life	Quality content
Basic accessories	Frame	12 months	Natural deformation, welding, detachment, and fracture caused by manufacturing defects can be replaced. Self-modification and collision damage are not covered by warranty.
	Front fork assembly, handlebars, folding seat post, seat post	12 months	Self-modification and collision damage are not covered by warranty.
	Tire	1 month	The tire is punctured by sharp objects, and tire problems caused by insufficient tire pressure or crossing speed bumps are not covered by warranty. Only products with quality problems upon receipt are eligible for warranty.

Basic accessories	Saddle, plastic parts, brakes, disc brake rotor, brake pads, brake cable	3 months	Parts damaged by collision or other causes are not covered by warranty. Damage crossing speed bumps is not covered by warranty.
	Motor Hall, motor bearing	12 months	Hall burnout, abnormal noise or rupture of bearing.
Battery	Battery casing, upper cover, lower cover, battery	12 months	Faults such as poor contact, power failure, no power storage, or capacity lower than 60% can be replaced. (Note: The warranty period for the battery does not restart, and the warranty period for the replaced battery is calculated based on the remaining days.) Water damage or damage caused by human factors is not covered by warranty replacement service.

The following conditions are not eligible for warranty:

- Malfunctions caused by the customer's failure to use, maintain, and adjust according to the user manual.
  - Malfunctions caused by the customer's self-disassembly, repair, modification, or failure to comply with the usage rules.
  - Malfunctions caused by improper use or storage by the customer or accidents.
  - Expenses incurred from repairs at other repair shops without our consent.
  - Slight scratches or damages to the outer packaging box of accessories due to logistics issues are not covered by the warranty.
  - Please contact us and obtain written approval before returning any items. Products returned without acceptance will not be refunded.
  - The warranty does not cover normal wear and tear of components.
  - Consumable parts (such as tires, saddles, plastic parts, brakes, brake rotors, brake pads, brake cables, surface scratches, etc.) are not covered by the warranty.
- Please kindly note: Used ebikes, modified ebikes are not covered by the warranty.

### 7.3 How to Apply for Warranty

Step 1: Take photos/short videos of your issue.

Step 2: Send a brief description of the problem, problem photos or videos, order number, and purchase platform to [service@engwe-bikes.com](mailto:service@engwe-bikes.com).

Step 3: We will diagnose your problem, and if the problem is clear, we will provide a solution.

Step 4: When encountering problems that cannot be diagnosed initially, we will send you a troubleshooting file that will require you to perform tests according to our testing methods and provide corresponding videos or photos. We will provide a solution after receiving the testing videos or photos.

Step 5: We will verify your order information and delivery address, and resend the corresponding accessories to you.

### 7.4 Contact Us

1. Tell:

+33 805980036 (EU) Business hours: 9 am to 6 pm (Greenwich Mean Time +1), Monday to Friday

+1 8442007117 (USA) Business hours: 9 am to 6 pm (Pacific Standard Time, Starting at 8 am), Monday to Friday

2. Email:

[service@engwe-bikes.com](mailto:service@engwe-bikes.com).

We usually reply within 1 working day.

## 8.Disclaimer

Please read the following carefully before using this electric bike. This disclaimer details your rights, responsibilities, and limitations when using the electric bike. By using this product, you agree to and accept the following terms:

1. Users must comply with all local laws and regulations, including but not limited to traffic rules, cycling safety standards, and legal restrictions on the use of this electric bike.

2. The vendor is not responsible for any malfunctions, accidents, or damages caused by the user's failure to operate, maintain, and adjust this product according to the user manual, maintenance manual, or safety guide.

3. Users are not allowed to disassemble, repair, or modify this product unless explicitly authorized by the vendor in writing. Any unauthorized modifications will void the warranty and increase the risks of use.

4. This product may involve certain risks, including but not limited to cycling accidents, falls, accidental collisions, or injuries. Users are responsible for their personal safety and should take appropriate safety measures when using this product.

5. The warranty for this product is limited to the defects and faults specified by the vendor. Damages, wear and tear, normal fatigue, or problems caused by accidents, improper use, storage, or maintenance are not covered by the warranty.

6. The vendor is not responsible for any damages or losses caused by logistics transportation. Users should inspect the packaging upon receipt and promptly contact the vendor to resolve any issues.

7. None of the terms in this disclaimer shall diminish the rights of users provided by applicable laws and regulations.

Please read and understand the above disclaimer carefully before using this product. If you do not agree with any of the terms, please do not use this electric bike. If you have any questions about any content in this disclaimer, please contact the Vendor for further explanation and guidance.